

Mozdólépcsők gumikorlátjai:

LT-3, LT-4, ET-3SZ

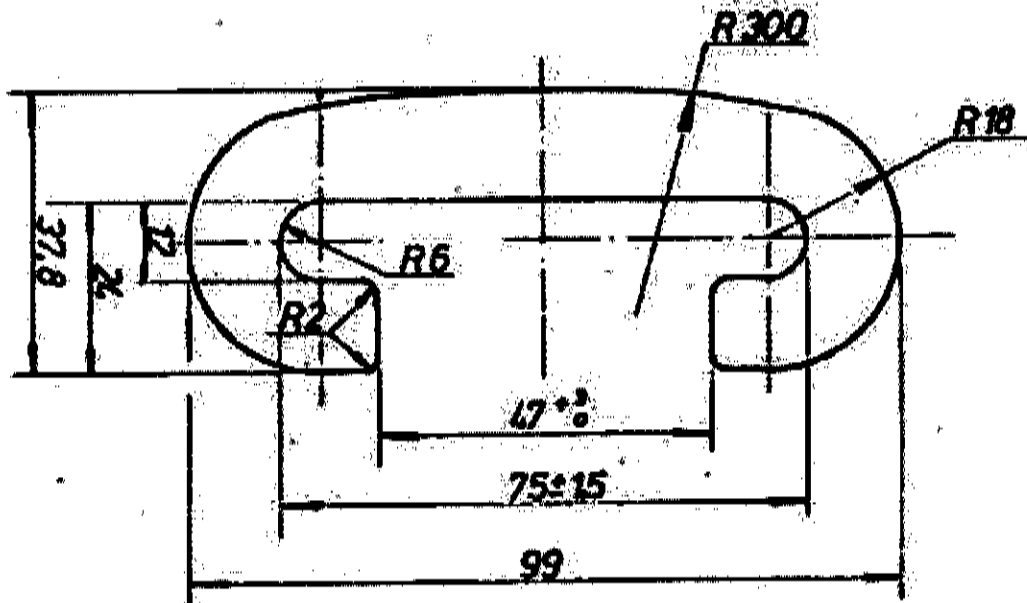

LP-6I, PST, OK-RTHD, OK-RTW

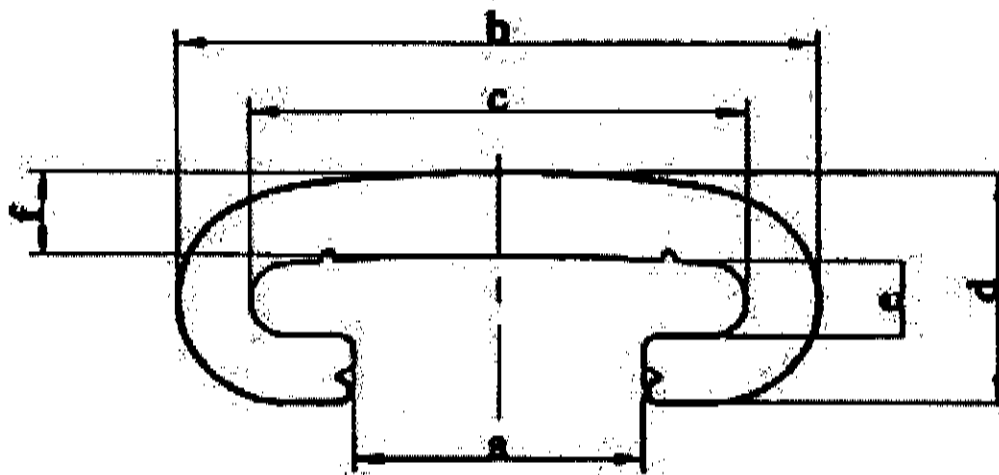

Megnevezés	[mm]
a	41
b	88
c	68
d	35
e	15
f	10,5

OK-RTHD M5

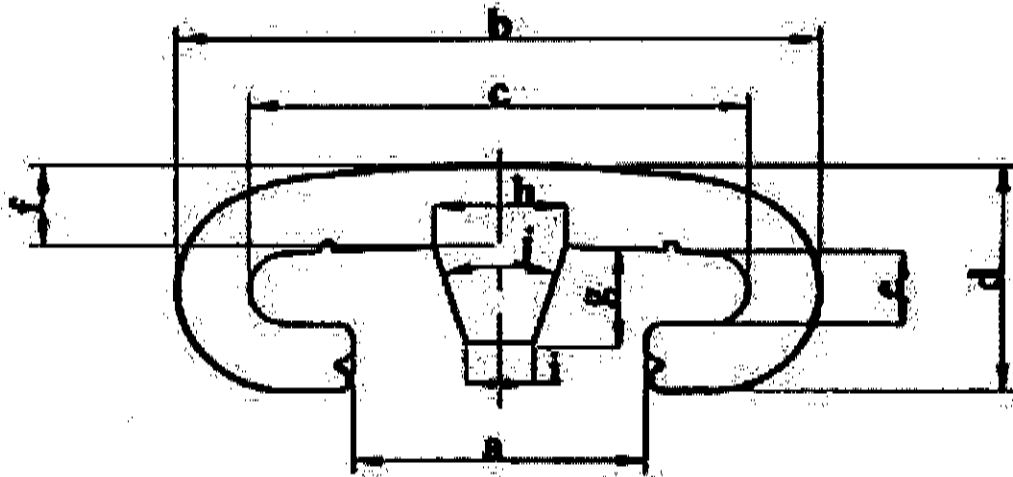

Megnevezés	[mm]
a	41
b	88
c	68
d	35
e	15
f	10,5
g	18
i	7
h/j	18

Otis 513 MPE

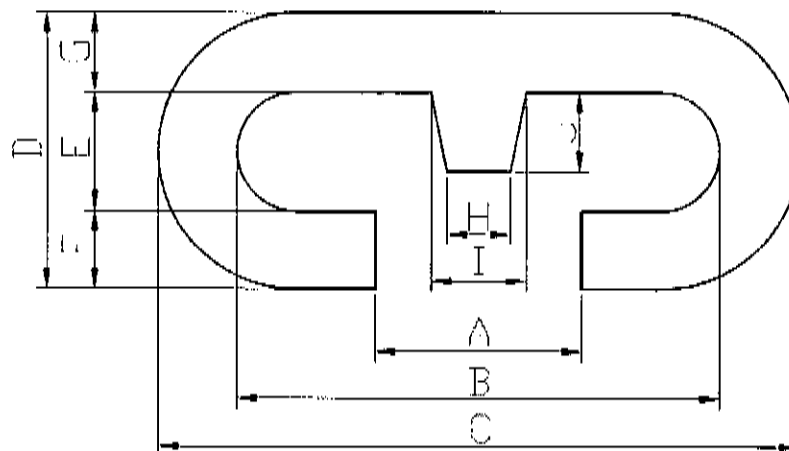

A	B	C^e	D	E
38	60	76	28	9,5
F	G	H	I	J
8,5	10	10	15,5	13

[mm]

Cnim 23E

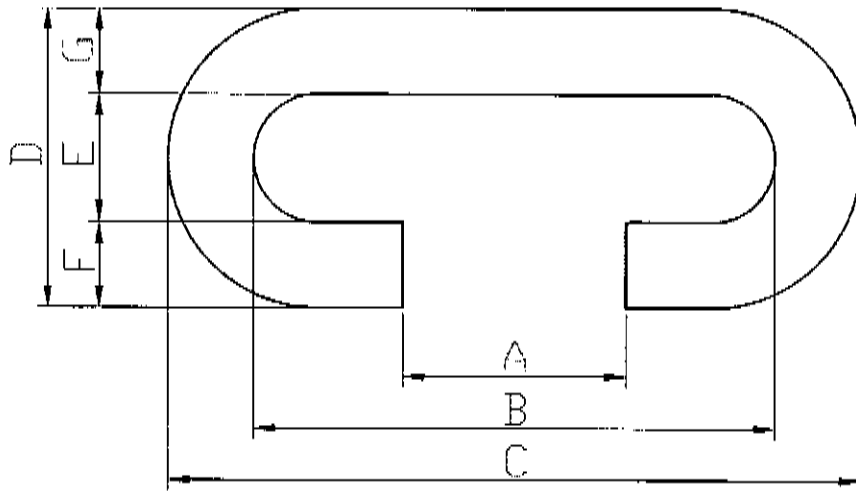

A	B	C	D	E
38	63	82	37	16
F	G			
~10,5	~10,5			

[mm]

Cnim 4P1

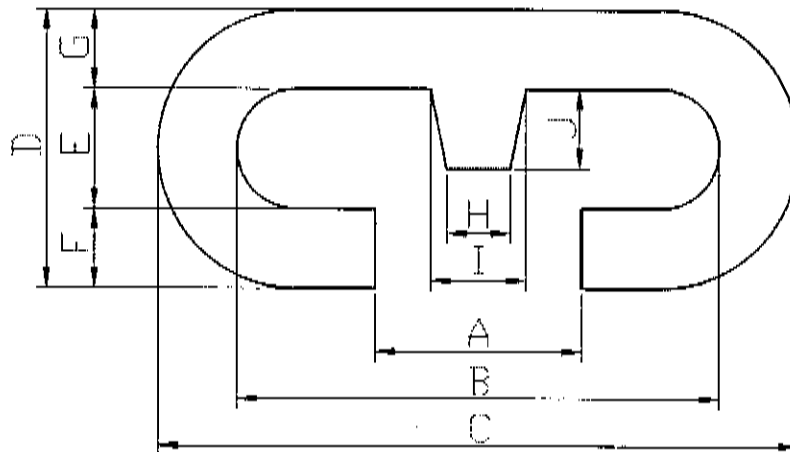

A	B	C	D	E
38	63	82	37	16
F	G	H	I	J
~10,5	~10,5	8	16	18,5

[mm]

Thyssen

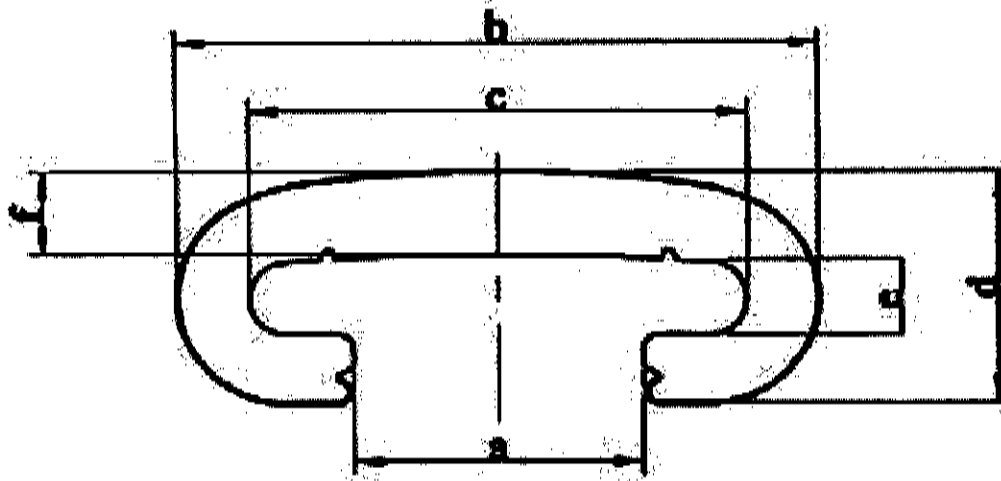

Megnevezés	[mm]
a	38
b	75
c	58
d	29
e	~9,5
f	~10